

Differential pressure gauge with output signal

For the process industry, all-metal media chamber

Models DPGT43.100, DPGT43.160

WIKA data sheet PV 17.05



for further approvals see
page 5

intelliGAUGE®

Applications

- Acquisition and display of processes
- Output signals 4 ... 20 mA, 0 ... 20 mA, 0 ... 10 V for the transmission of process values to the control room
- For measuring points with increased differential overpressure
- Easy-to-read, analogue on-site display needing no external power
- Safety-related applications

Special features

- No configuration necessary due to "plug-and-play"
- Signal transmission per NAMUR
- Differential pressure measuring ranges from 0 ... 16 mbar
- Easy-to-read analogue display with nominal sizes 100 and 160
- Individual, non-linear characteristic curves (e.g. x^2 or \sqrt{x} for flow measurement)

Description

Wherever the process pressure has to be indicated locally and, at the same time, a signal transmission to the central control or remote centre is desired, the model DPGT43 intelliGAUGE® (patent, property right: e.g. DE 202007019025) can be used.

The model DPGT43 is based upon a model 732.51 high-quality, stainless steel pressure gauge with a nominal size of 100 or 160. The pressure measuring instrument is manufactured in accordance with EN 837-3.

These differential pressure gauges are made of highly corrosion-resistant stainless steel and feature an all-metal sealing of the media chamber.

Therefore no elastomer sealing elements are required, so that a better long-term leak tightness is ensured. A high overload safety is achieved by the all-metal construction and the close-fitting design of the pressure element.



Differential pressure gauge model DPGT43.100

The robust diaphragm measuring system produces a pointer rotation proportional to the pressure. An electronic angle encoder, proven in safety-critical automotive applications, determines the position of the pointer shaft – it is a non-contact sensor and therefore completely free from wear and friction. From this, the electrical output signal proportional to the pressure, e.g. 4 ... 20 mA, is produced. The measuring span (electrical output signal) is adjusted automatically along with the mechanical display, i.e. the scale over the full display range corresponds to 4 ... 20 mA. The electrical zero point can also be set manually.

The electronic WIKA sensor, integrated into the high-quality mechanical differential pressure gauge, combines the advantages of electrical signal transmission with a local mechanical display that remains readable during a power failure. An additional measuring point for mechanical pressure display can thus be saved.

Specifications

Models DPGT43.100, DPGT43.160	
Version	Process connections lower mount or lateral (option), highly corrosion-resistant solid metal design, measuring cell protected against unauthorised access. Overload resistance per EN 837-3
Nominal size in mm	<ul style="list-style-type: none"> ■ 100 ■ 160
Accuracy class	1.6 Option: 1.0
Scale ranges	0 ... 16 mbar to 0 ... 250 mbar 0 ... 400 mbar to 0 ... 40 bar other units (e.g. psi, kPa) available or all other equivalent vacuum or combined pressure and vacuum ranges
Scale	Single scale Option: <ul style="list-style-type: none"> ■ Dual scale ■ Scale layout with individual non-linear characteristic curves
Pressure limitation	
Steady	Full scale value
Fluctuating	0.9 x full scale value Observe the recommendations for the use of mechanical pressure measuring systems in accordance with EN 837-2
Overload safety and max. working pressure (static pressure)	see table on page 3
Connection location	Lower mount (radial) Option: lateral (right, left, front or back)
Process connection	<ul style="list-style-type: none"> ■ 2 x G ¼ B female ■ 2 x G ½ B male ■ 2 x ½ NPT male Other process connections via female or male threads on request
Permissible temperature ¹⁾	
Medium	-20 ... +100 °C Option: Medium temperature > 100 °C on request
Ambient	-20 ... +60 °C (with window from polycarbonate max. 80 °C)
Temperature effect	When the temperature of the measuring system deviates from the reference temperature (+20 °C): max. ±0.5 %/10 K of full scale value
Case	<ul style="list-style-type: none"> ■ Version S1 per EN 837: With blow-out device in case back ■ Safety version S3 per EN 837: With solid baffle wall (Solidfront) and blow-out back
Case filling	Without Option: With case filling
Venting of the media chamber	With scale ranges ≤ 0.25 bar Option: With scale ranges ≥ 0.4 bar

¹⁾ For hazardous areas, the permissible temperatures of the output signal variant 2 will apply exclusively (see page 4). These must not be exceeded at the instrument either (for details see operating instructions). If necessary, measures for cooling (e.g. syphon, instrumentation valve, etc.) have to be taken.

Models DPGS43.100, DPGS43.160

Wetted materials

Media chamber with process connection	Stainless steel 316Ti (1.4571)
Pressure elements	≤ 0.25 bar: Stainless steel 316L > 0.25 bar: NiCr alloy (Inconel)
Bellows, venting of the media chamber (option)	Stainless steel 316Ti (1.4571)
	Stainless steel 316Ti (1.4571)

Non-wetted materials

Movement	Brass
Dial	Aluminium, white, black lettering
Pointer	Aluminium, black
Case	Stainless steel, with blow-out device
Window	Laminated safety glass
Ring	Bayonet ring, stainless steel

Ingress protection per IEC/EN 60529	IP54 ¹⁾ Option: IP65 with liquid filling
--	---

Installation	according to affixed symbols: ⊕ high pressure, ⊖ low pressure
---------------------	---

Mounting	<ul style="list-style-type: none"> ■ Rigid measuring lines ■ Mounting holes in measuring flange Option: <ul style="list-style-type: none"> ■ Panel mounting flange ■ Instrument mounting bracket for wall or pipe mounting
-----------------	--

1) Ingress protection IP54 with safety version and lower back mount.

Overload safety and max. working pressure

Scale ranges	Overload safety in bar either side max.		Max. working pressure in bar (static pressure)	
	Standard	Option	Standard	Option
0 ... 16 to 0 ... 40 mbar	2.5	-	2.5	6 ²⁾
0 ... 60 to 0 ... 250 mbar	2.5	6	6	10
0 ... 400 mbar	4	40	25	40
0 ... 0.6 bar	6	40	25	40
0 ... 1 bar	10	40	25	40
0 ... 1.6 bar	16	40	25	40
0 ... 2.5 to 0 ... 25 bar	25	40	25	40

2) Accuracy class 2.5

Options

Restrictor in the pressure port

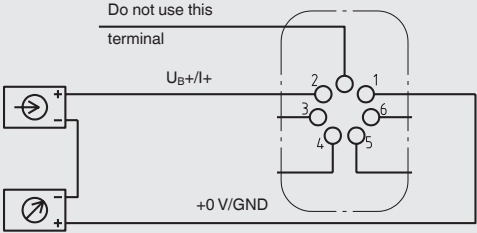
Models DPGT43.100 and DPGT43.160	
Output signal	Variant 1: 4 ... 20 mA, 2-wire, passive, per NAMUR NE 43 Variant 2: 4 ... 20 mA, 2-wire, for hazardous areas Variant 3: 0 ... 20 mA, 3-wire Variant 4: 0 ... 10 V, 3-wire
Supply voltage U_B	DC 12 V < U_B ≤ 30 V (variant 1 and 3) DC 14 V < U_B ≤ 30 V (variant 2) DC 15 V < U_B ≤ 30 V (variant 4)
Influence of supply voltage	≤ 0.1 % of full scale/10 V
Permissible residual ripple of U_B	≤ 10 % ss
Permissible max. load R_A	Variants 1, 2, 3: $R_A \leq (U_B - 12 \text{ V})/0.02 \text{ A}$ with R_A in Ω and U_B in V, however max. 600 Ω Variant 4: $R_A = 100 \text{ k}\Omega$
Effect of load (variant 1, 2, 3)	≤ 0.1 % of full scale
Impedance at voltage output	0.5 Ω
Electrical zero point	Through a jumper across terminals 5 and 6 (see operating instructions)
Long-term stability of electronics	< 0.3 % of full scale per year
Electr. output signal	≤ 1 % of measuring span
Linear error	≤ 1 % of measuring span (terminal method)
Resolution	0.13 % of full scale (10 bit resolution at 360°)
Refresh rate (measuring rate)	600 ms
Electrical connection	Cable socket PA 6, black Per VDE 0110 insulation group C/250 V Cable gland M20 x 1.5 Strain relief 6 screw terminals + PE for conductor cross-section 2.5 mm ²
Designation of connection terminals, 2-wire (variant 1 and 2)	 <p>Do not use this terminal</p> <p>$U_B+/I+$</p> <p>3</p> <p>4</p> <p>5</p> <p>6</p> <p>+0 V/GND</p> <p>Terminals 3 and 4: For internal use only Terminals 5 and 6: Reset zero point</p>
Designation of connection terminals for 3-wire (variant 3 and 4), see operating instructions	

Safety-related maximum values (variant 2)

U_i	I_i	P_i	C_i	L_i
DC 30 V	100 mA	720 mW	11 nF	negligible









Permissible temperature ranges (variant 2)

T6	T5	T4 ... T1
-20 ... +45 °C	-20 ... +60 °C	-20 ... +70 °C

T85°C	T100°C	T135°C
-20 ... +45 °C	-20 ... +60 °C	-20 ... +70 °C

For further information on hazardous areas, see operating instructions.

Approvals

Logo	Description	Country
	EU declaration of conformity <ul style="list-style-type: none"> ■ EMC directive ■ RoHS directive ■ ATEX directive (option) Hazardous areas <ul style="list-style-type: none"> - Ex ia Gas [II 2G Ex ia IIC T6/T5/T4 Gb] Dust [II 2D Ex ia IIIB T85 °C/T100 °C/T135 °C Db] 	European Union
	IECEx (option) Hazardous areas <ul style="list-style-type: none"> - Ex ia Gas [Ex ia IIC T6/T5/T4 Gb] Dust [Ex ia IIIB T85 °C/T100 °C/T135 °C Db] 	International
	EAC (option) <ul style="list-style-type: none"> ■ EMC directive ■ Pressure equipment directive ■ Low voltage directive ■ Hazardous areas 	Eurasian Economic Community
	GOST (option) Metrology, measurement technology	Russia
	KazInMetr (option) Metrology, measurement technology	Kazakhstan
-	MTSCHS (option) Permission for commissioning	Kazakhstan
	BelGIM (option) Metrology, measurement technology	Belarus
	UkrSEPRO (option) Metrology, measurement technology	Ukraine
	DNOP (MakNII) (option) Hazardous areas	Ukraine
	Uzstandard (option) Metrology, measurement technology	Uzbekistan
-	CRN Safety (e.g. electr. safety, overpressure, ...)	Canada

Certificates (option)

- 2.2 test report per EN 10204 (e.g. state-of-the-art manufacturing, indication accuracy)
- 3.1 inspection certificate per EN 10204 (e.g. indication accuracy)

Patents, property rights

Pointer measuring instrument with output signal 4 ...
20 mA (patent, property right: e.g. DE 202007019025,
US 2010045366, CN 101438333)

Approvals and certificates, see website

Accessories

- Sealings (model 910.17, see data sheet AC 09.08)
- Valves (models IV3x/IV5x, see data sheet AC 09.23)
- Diaphragm seal

Dimensions in mm

intelliGAUGE® models DPGT43.100 and DPGT43.160

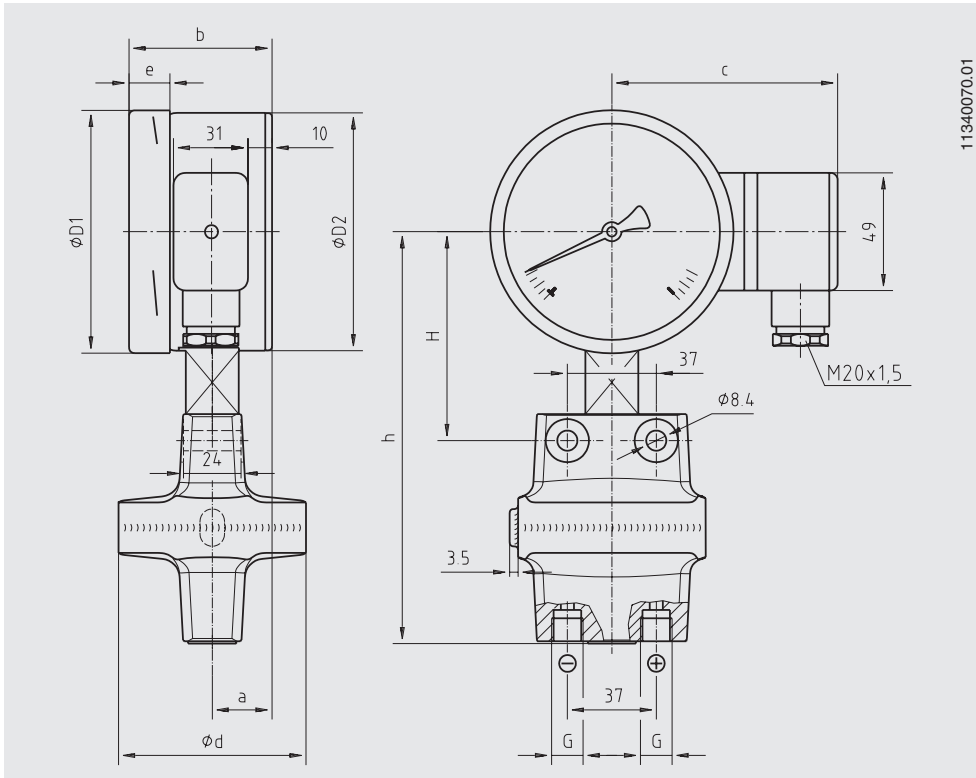

NS	Scale range	Dimensions in mm										Weight in kg
		a	b	c	d	D ₁	D ₂	e	G	h ±1	H	
100	≤ 0 ... 250 mbar	25	59.5	94	140	101	99	17	G ¼	161	90	2.7
100	> 0 ... 250 mbar	25	59.5	94	78	101	99	17	G ¼	171	87	1.9
160	≤ 0 ... 250 mbar	25	65	124	140	161	159	17	G ¼	191	120	3.4
160	> 0 ... 250 mbar	25	65	124	78	161	159	17	G ¼	201	117	2.4

Ordering information

Model / Nominal size / Scale range / Output signal / Connection location / Process connection / Scale layout (linear pressure or square root incrementation) / Max. working pressure (static pressure) / Options

© 11/2007 WIKA Alexander Wiegand SE & Co. KG, all rights reserved.
The specifications given in this document represent the state of engineering at the time of publishing.
We reserve the right to make modifications to the specifications and materials.

